

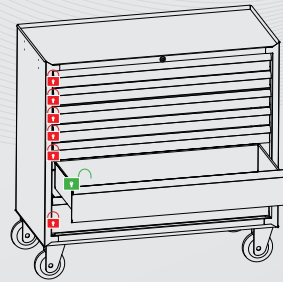

Risk-Free Tool Trolley

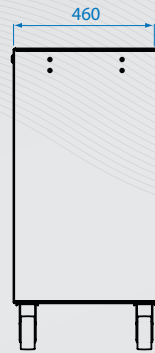

INDUSTRIAL

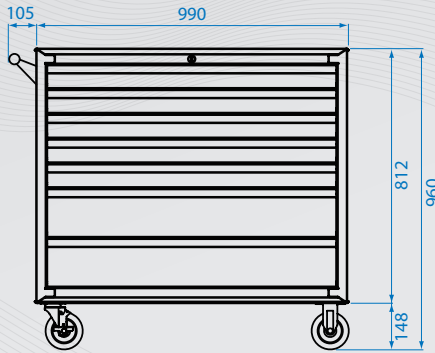
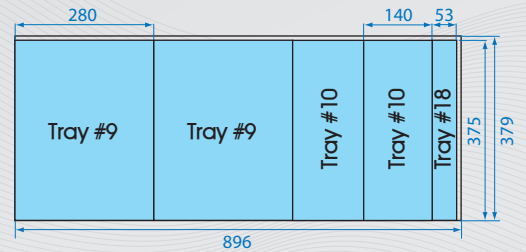
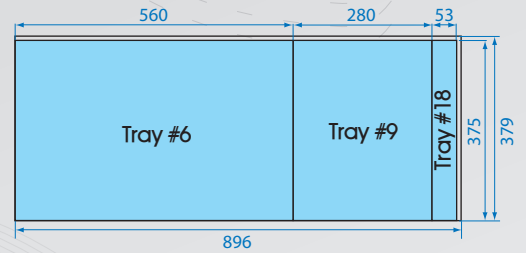

Only open one drawer to prevent tilting risk!

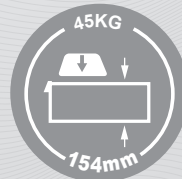
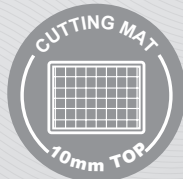
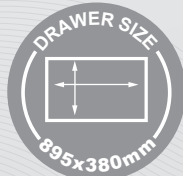
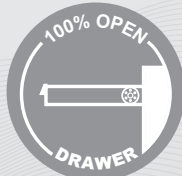

KT NO.

Spec.

Dimension(mm)
Width x Depth x Height

Casters

Static load



CUFT

new 87462-7G

Overall	953 x 460 x 812
Overall+5" Casters	990 x 460 x 960
5 Drawer	895 x 380 x 75
2 Drawer	895 x 380 x 154

5" x 1-1/4"

600 Kg

83

21.17