



# Gear Puller

- Material - chrome vanadium alloy steel
- Finishing - chrome plated & phosphate sunk

## 7962

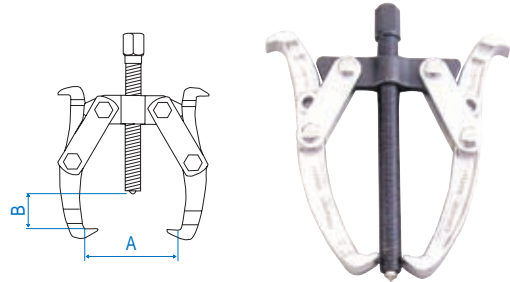

- Two-Jaw gear puller

KT NO.	Size inch	A mm	B mm		
7962-03	3	75	60	0.44	1 / 40
7962-04	4	100	95	0.78	1 / 20
7962-06	6	150	150	1.65	1 / 10
7962-08	8	200	235	3.50	1 / 5
7962-12	12	300	280	7.00	1 / 2



## 7963

- Three-Jaw gear puller

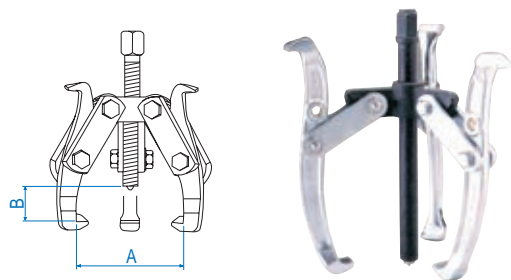

KT NO.	Size inch	A mm	B mm		
7963-03	3	75	60	0.55	1 / 40
7963-04	4	100	95	1.06	1 / 20
7963-06	6	150	150	2.25	1 / 10
7963-08	8	200	235	4.50	1 / 5
7963-12	12	300	280	11.00	1 / 2

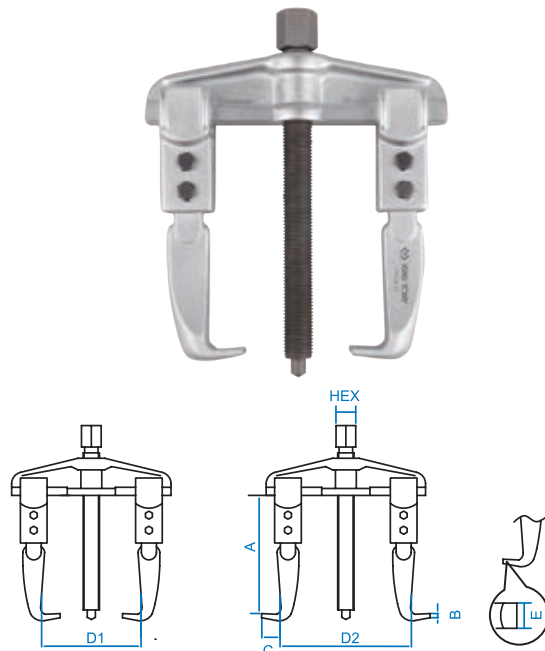
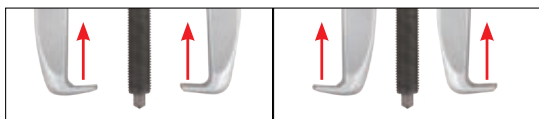

## 7962B new

- Two-Jaw gear puller
- Adjustable sliding arm for efficiency and safety
- Reversible jaws for internal & external options gear, axle, bearing, etc...



KT NO.	Size inch	Hex mm	A mm	B mm	C mm	D1 mm	D2 mm min	D2 mm max	E mm		
7962B-35	3.5	17	100	3.8	14.5	90	60	125	21	1.05	1/12
7962B-05	5	17	100	3.8	14.5	130	60	160	21	1.15	1/12
7962B-06	6	22	150	4.6	23	150	85	200	30	2.98	1/6
7962B-08	8	22	150	4.6	23	190	105	230	30	3.41	1/6
7962B-10	10	27	210	7.0	30	240	130	300	35	7.11	1/3